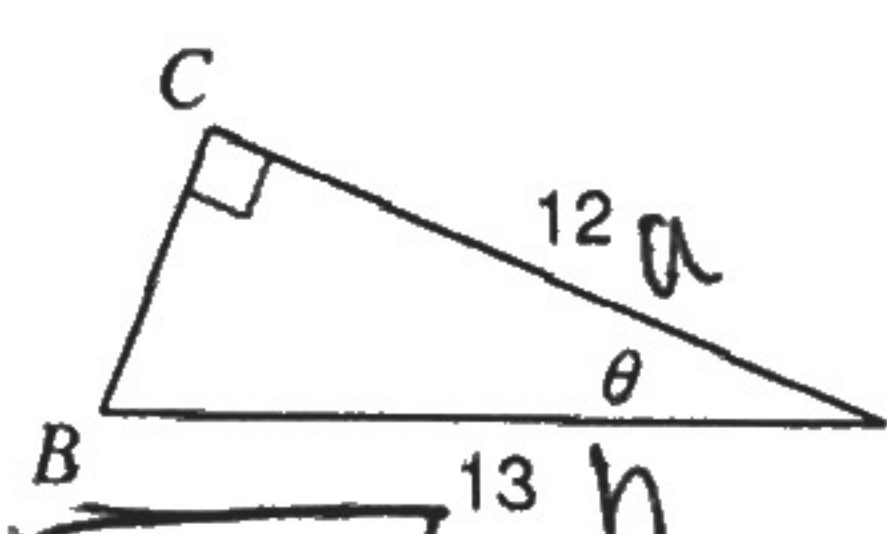
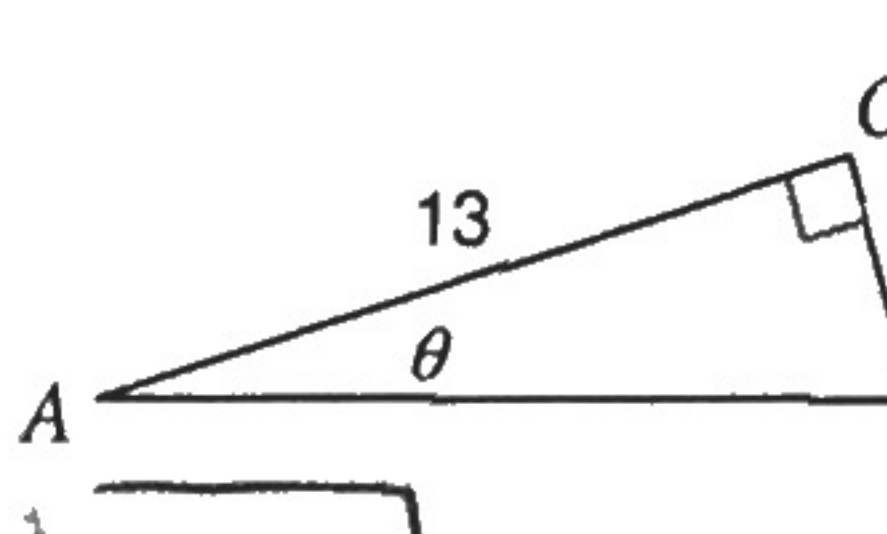
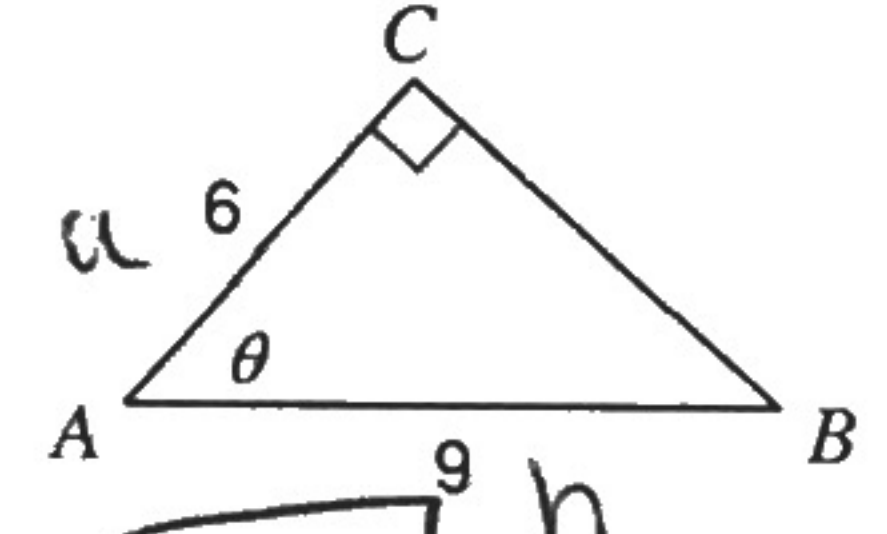

Right Triangle Trig. - Finding Missing Sides and Angles

Find the measure of each angle indicated. Round to the nearest tenth.

1)  $\cos \theta = \frac{12}{13}$
 $\theta = \cos^{-1}\left(\frac{12}{13}\right)$
 $\theta = 22.6^\circ$

2)  $\tan \theta = \frac{4}{13}$
 $\theta = \tan^{-1}\left(\frac{4}{13}\right)$
 $\theta = 17.1^\circ$

3)  $\cos \theta = \frac{6}{9}$
 $\theta = \cos^{-1}\left(\frac{6}{9}\right)$
 $\theta = 48.2^\circ$

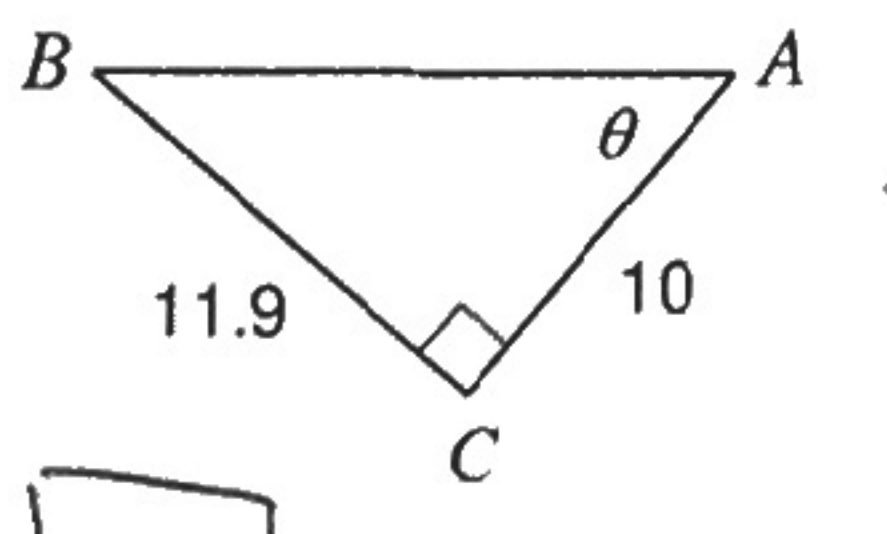
4)  $\tan \theta = \frac{11.9}{10}$
 $\theta = \tan^{-1}\left(\frac{11.9}{10}\right)$
 $\theta = 50^\circ$

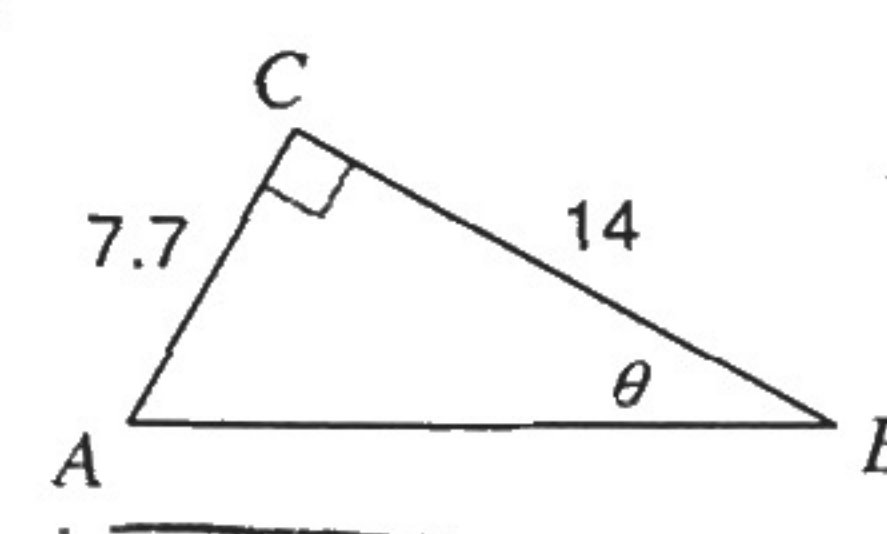
5)  $\tan \theta = \frac{7.7}{14}$
 $\theta = \tan^{-1}\left(\frac{7.7}{14}\right)$
 $\theta = 28.8^\circ$

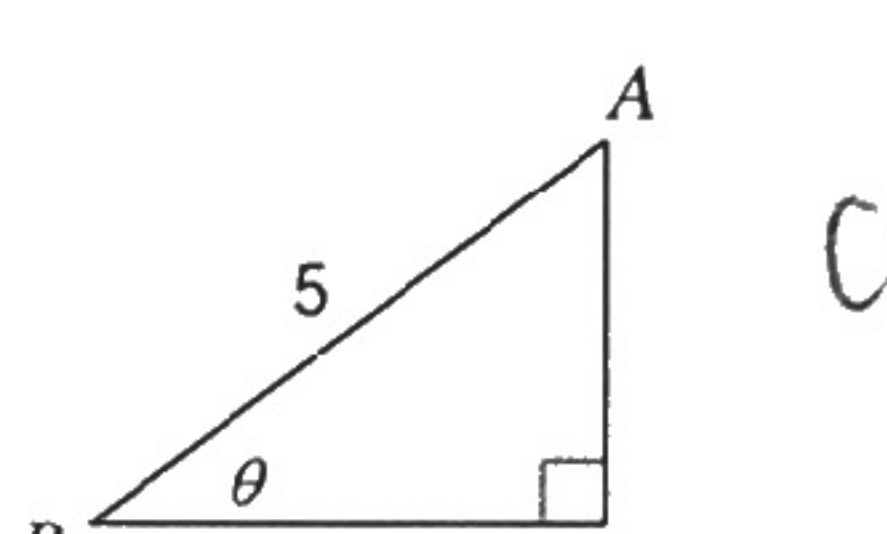
6)  $\cos \theta = \frac{4}{5}$
 $\theta = \cos^{-1}\left(\frac{4}{5}\right)$
 $\theta = 36.9^\circ$

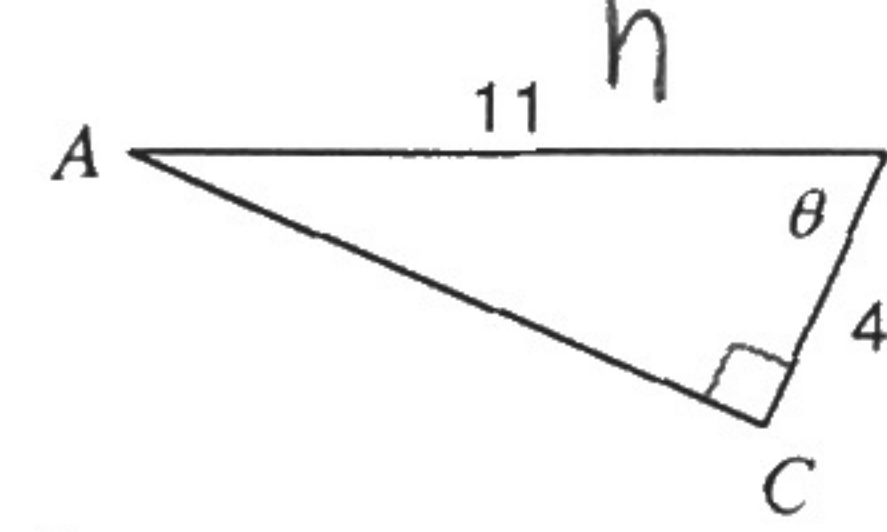
7)  $\cos \theta = \frac{4.4}{11}$
 $\theta = \cos^{-1}\left(\frac{4.4}{11}\right)$
 $\theta = 66.4^\circ$

8)  $\tan \theta = \frac{3}{3}$
 $\theta = \tan^{-1}(1)$
 $\theta = 45^\circ$

Find the measure of each side indicated. Round to the nearest tenth.

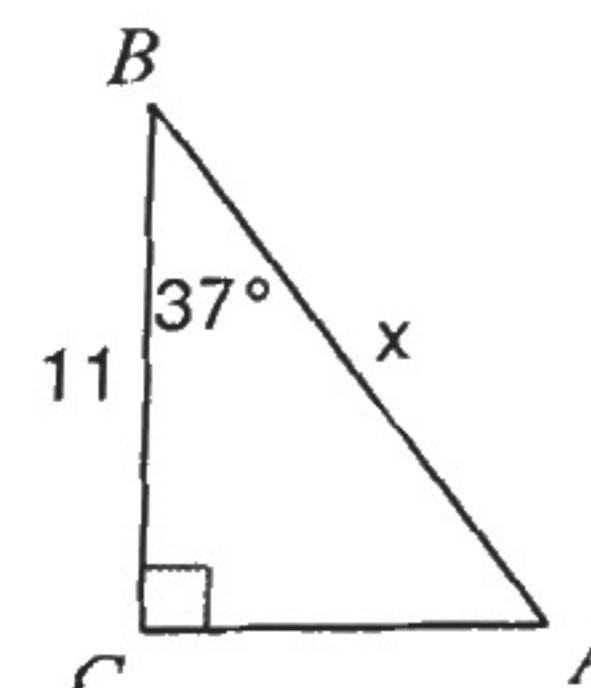
9)  $\cos 37 = \frac{11}{x}$
 $x \cos 37 = 11$
 $x = \frac{11}{\cos 37}$
 $x = 13.8$

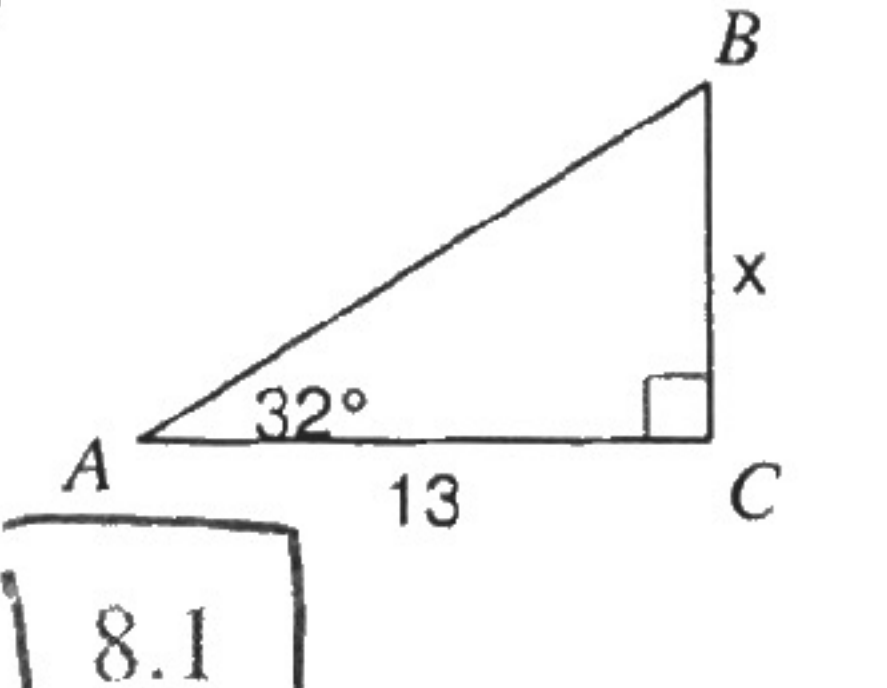
10)  $\tan 32 = \frac{x}{13}$
 $x = 13 \tan 32$
 $x = 8.1$

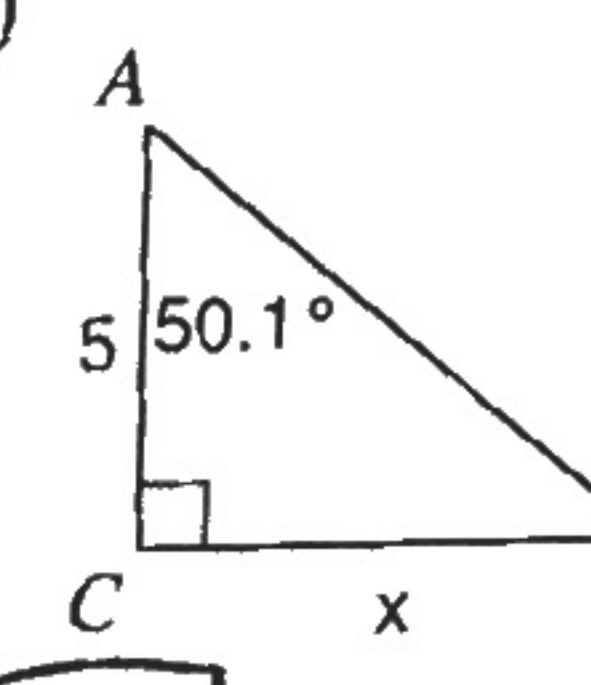
11)  $\tan 50.1 = \frac{x}{5}$
 $x = 5 \tan 50.1$
 $x = 6$

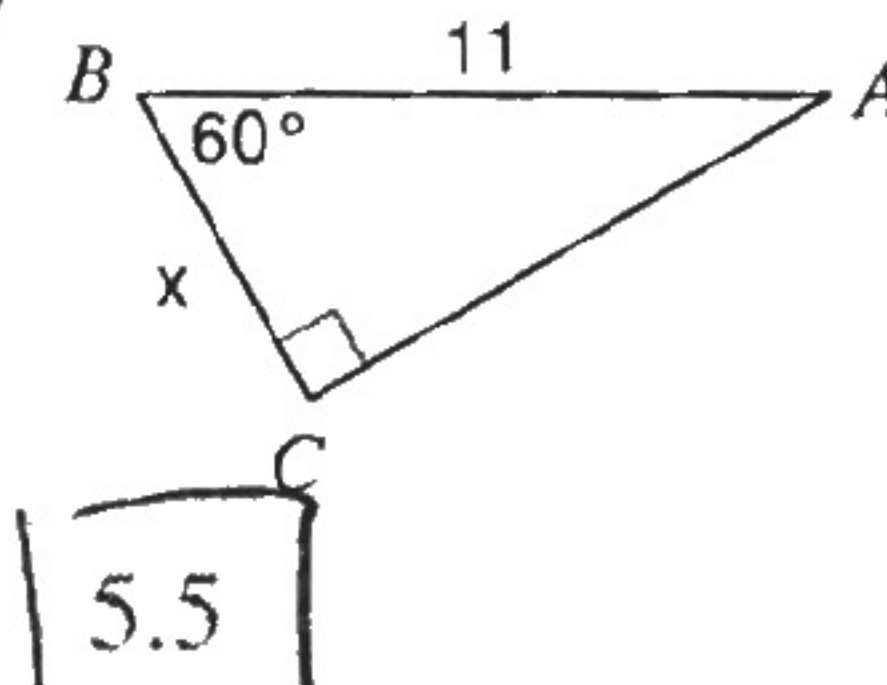
12)  $\cos 60 = \frac{x}{11}$
 $x = 11 \cos 60$
 $x = 5.5$

13)

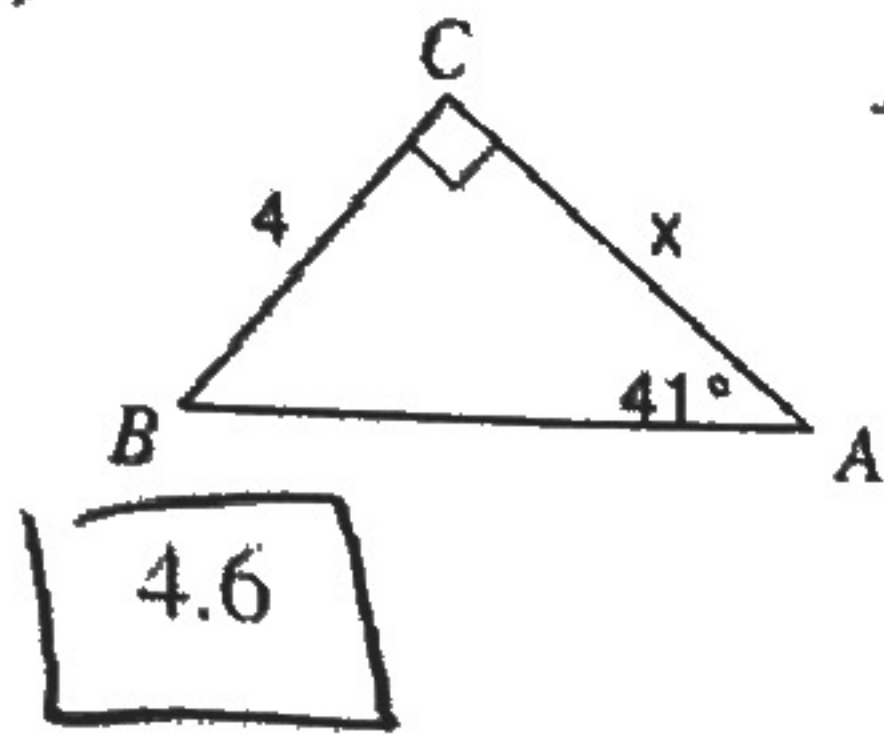

$$\tan 41 = \frac{4}{x}$$

$$x \tan 41 = 4$$

$$x = \frac{4}{\tan 41}$$

14)

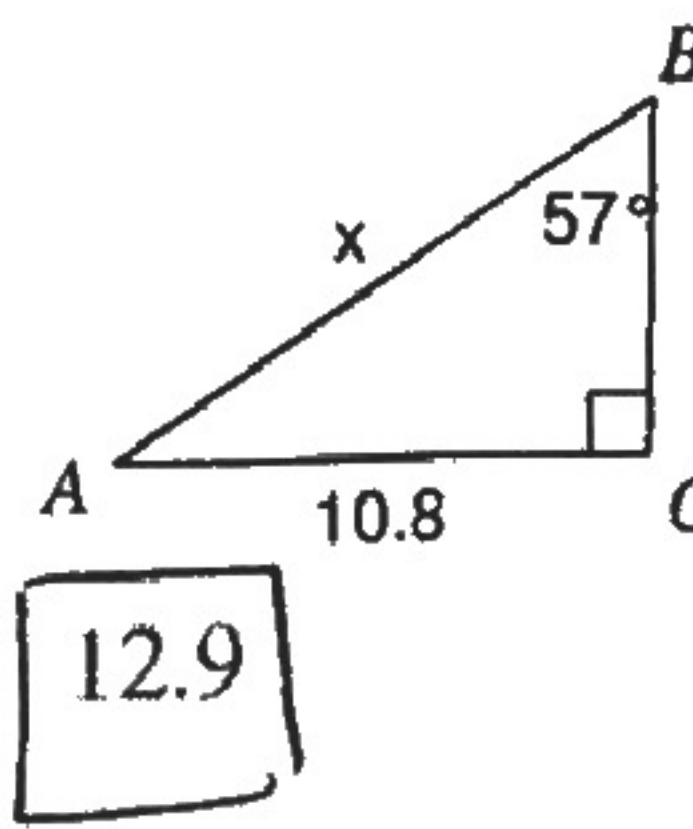

$$\sin 57 = \frac{10.8}{x}$$

$$x \sin 57 = 10.8$$

$$x = \frac{10.8}{\sin 57}$$

15)

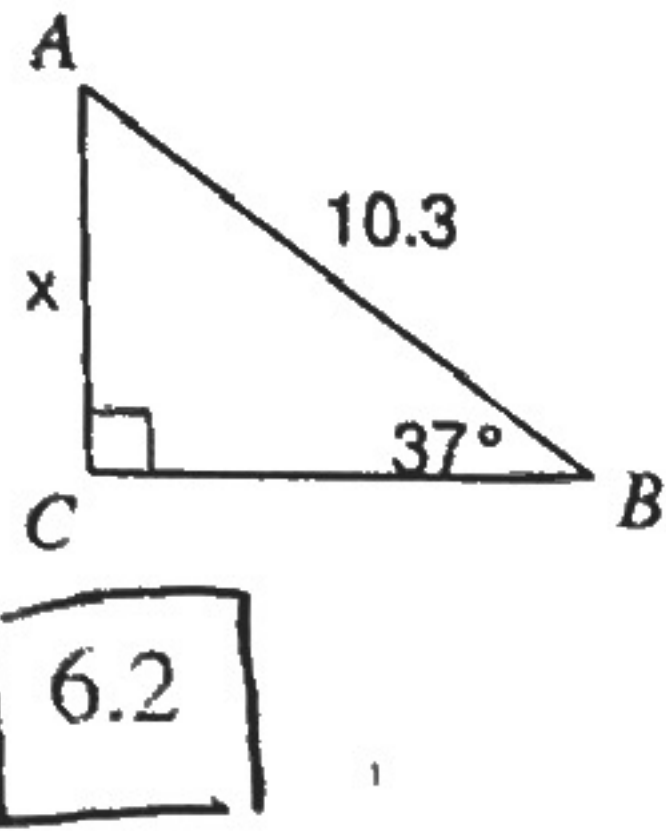

$$\sin 37 = \frac{x}{10.3}$$

$$x = 10.3 \sin 37$$

16)

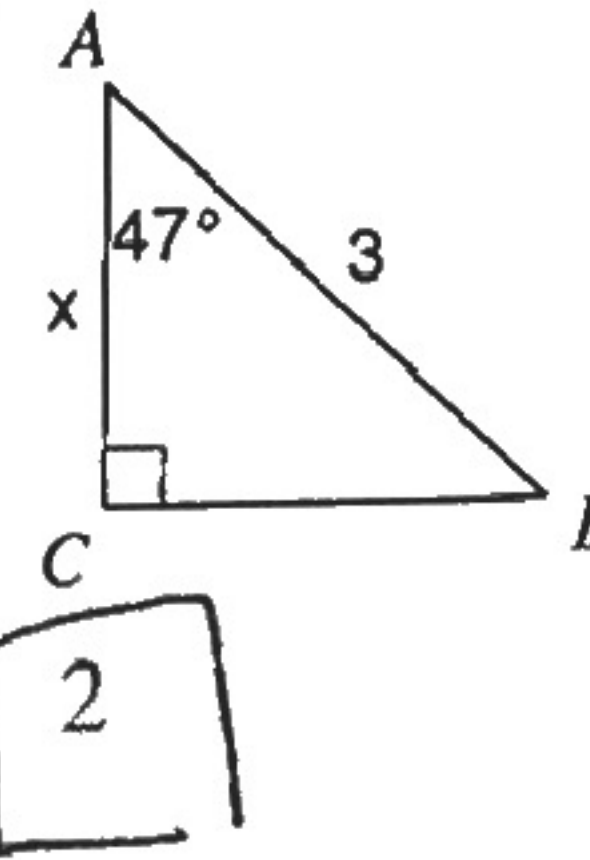

$$\cos 47 = \frac{x}{3}$$

$$x = 3 \cos 47$$

Solve each triangle. Round answers to the nearest tenth. *pick 4*

17)

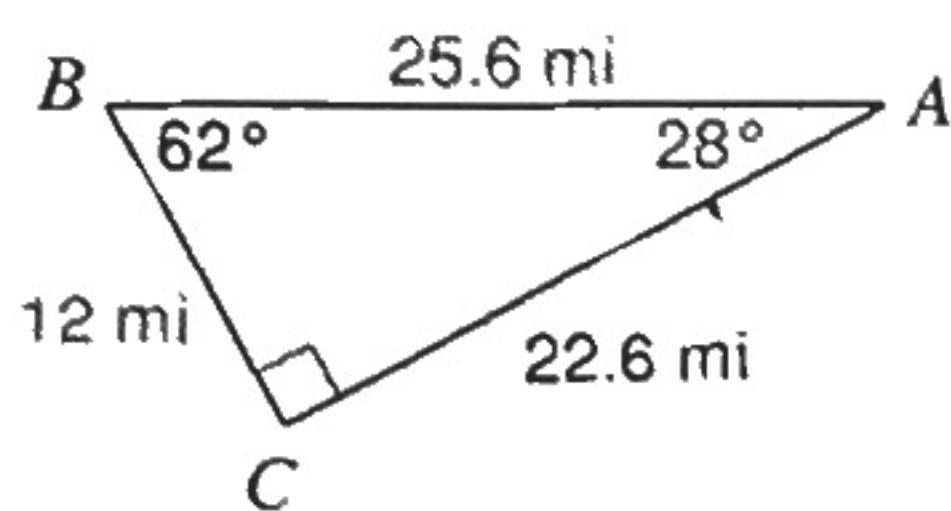

18)

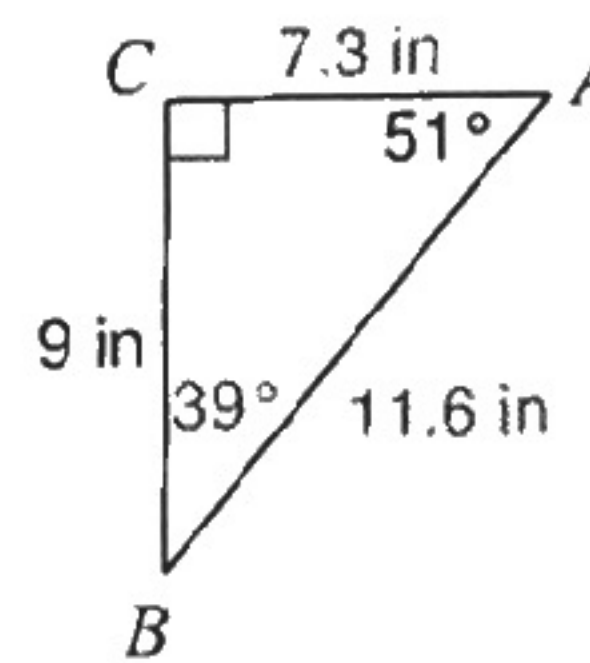

19)

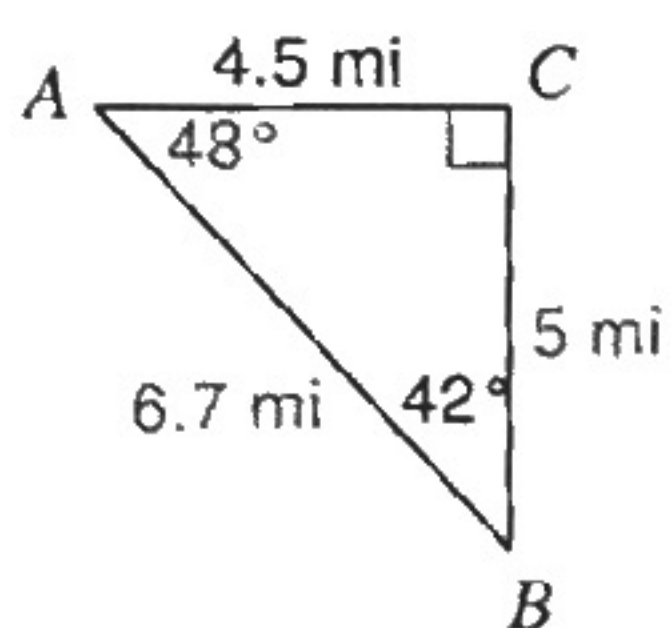

20)

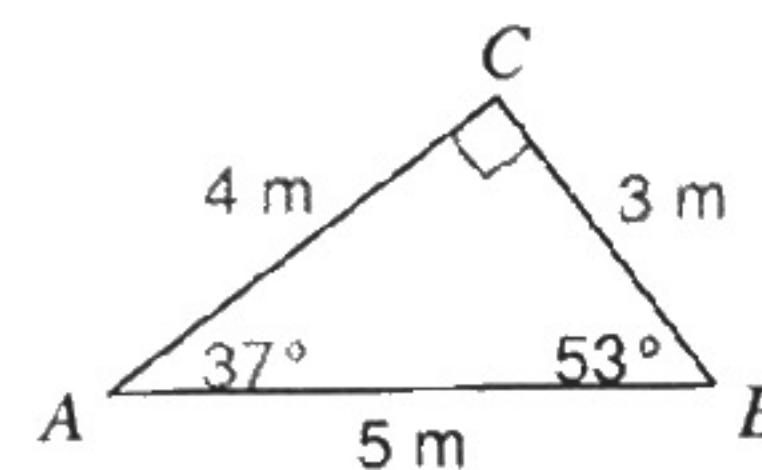

21)

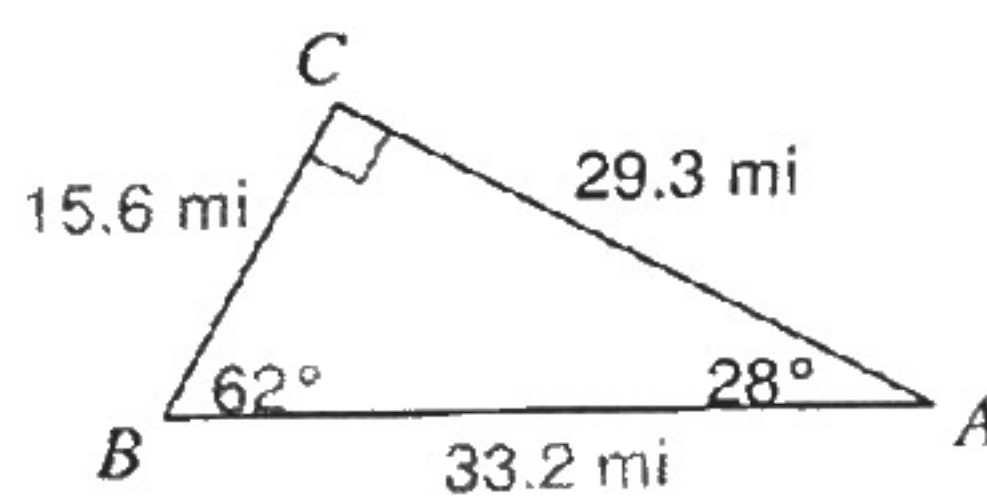

22)

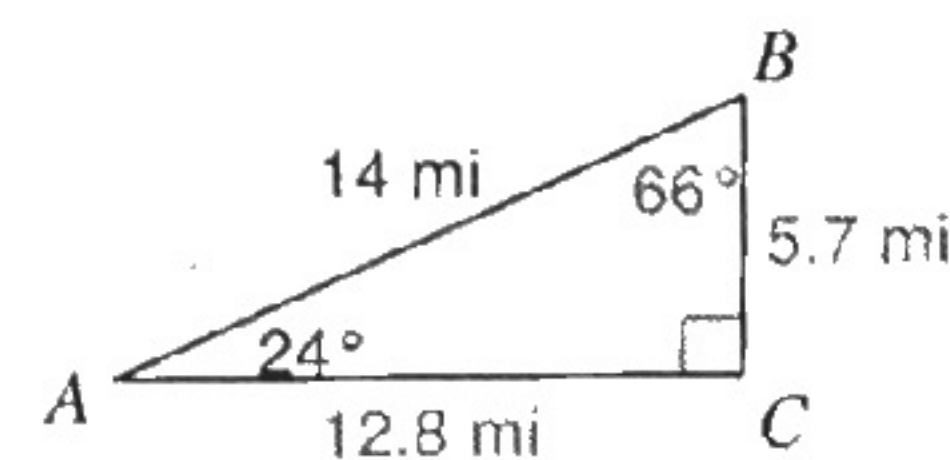

23)

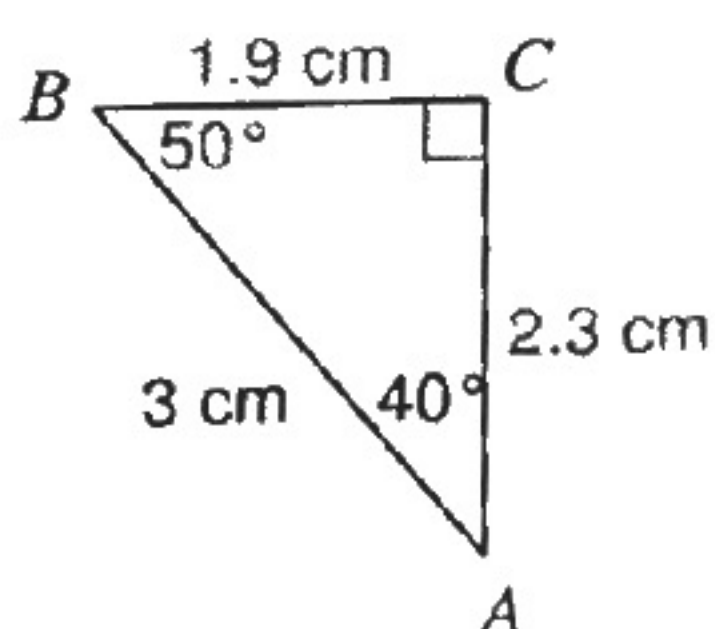

24)

